

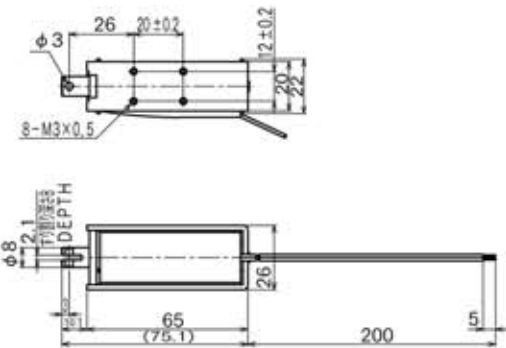

外形寸法
Dimensions

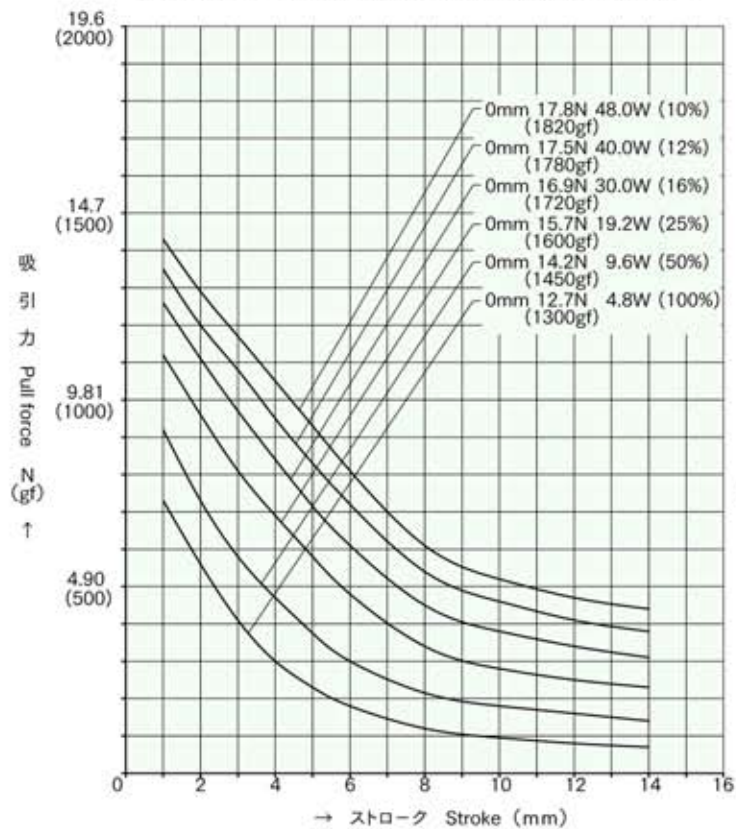

■ ストローク / 吸引力特性 Stroke and Pull Force Characteristics



■ 容量 / 吸引力特性 Power and Pull Force Characteristics

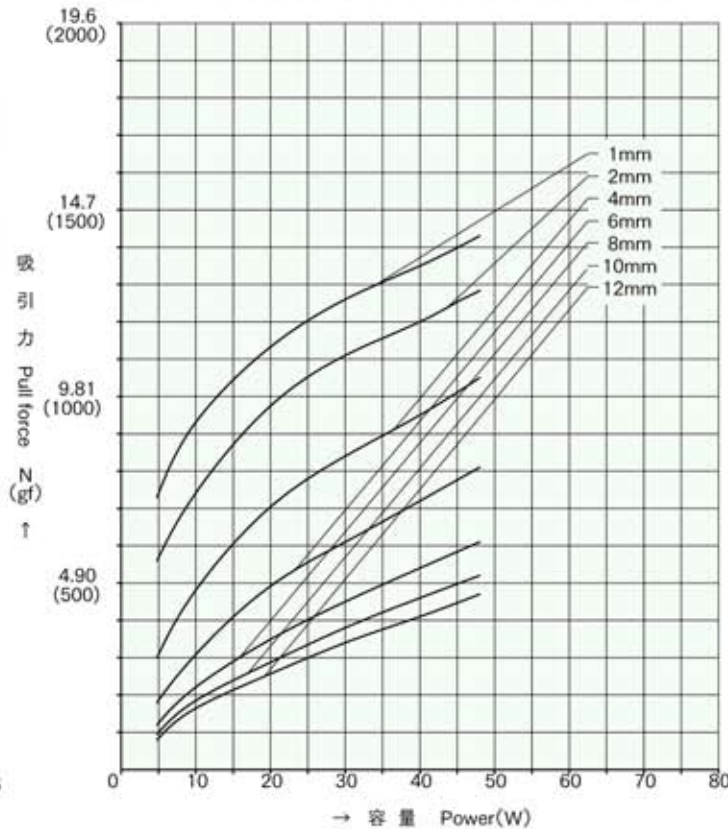

標準コイル表 連続定格 4.8W
Standard Coil Specifications
Cont. rating 4.8W

電圧 (V) Voltage	抵抗 (Ω) Resistance	電流 (mA) Current
6	7.5	800
12	30	400
24	120	200

- 総重量 : 164.0g
Total weight
- プランジャー重量 : 24.0g
Plunger weight